

## KASUTUSJUHE

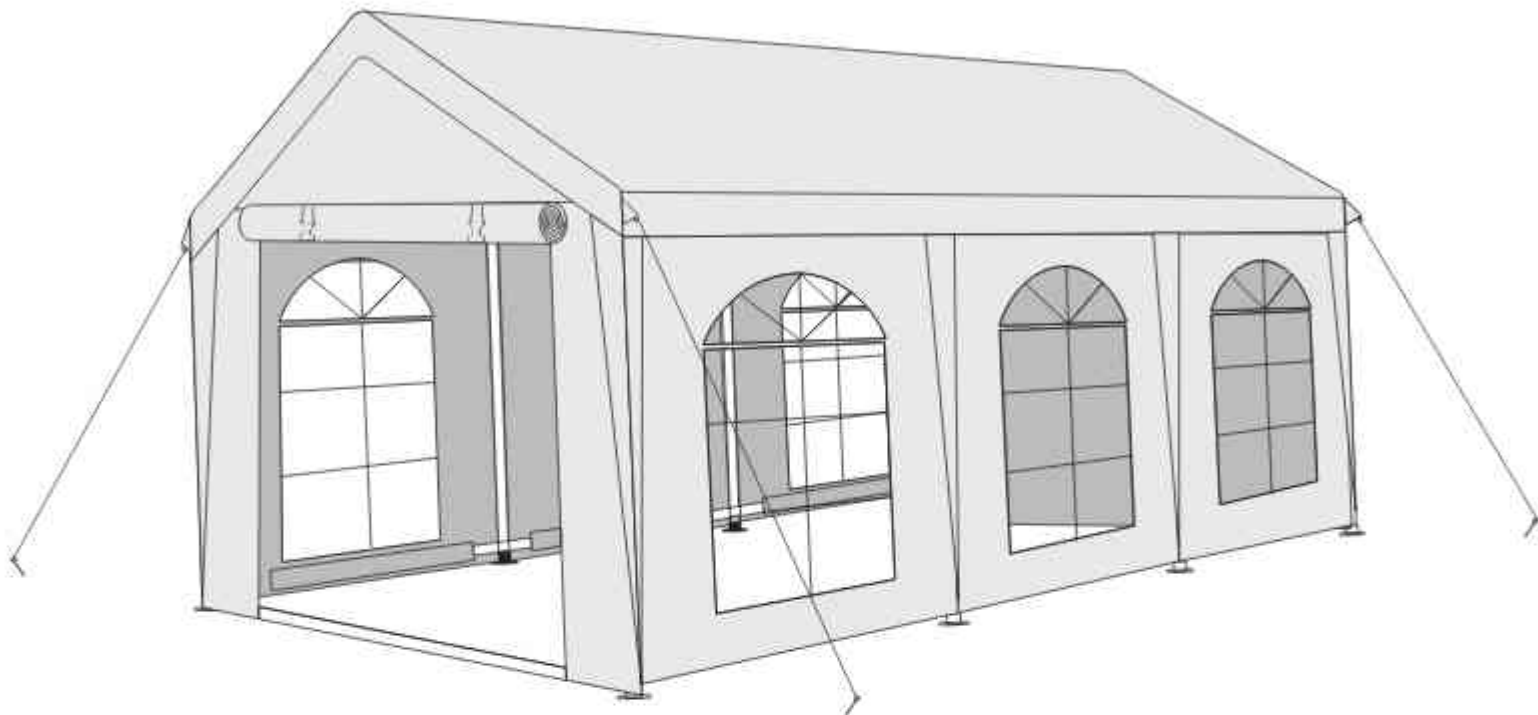

### SOOVITUSED PAIGALDUSEKS JA HOOLDUSEKS

**Meeskondlik paigaldus:** Arvestades mõõtmeid 4x6 m ja komponentide arvu (nt 34 kruvi M6\*50 ja 62 elastset aasa), soovitame paigaldust teostada vähemalt 2 kuni 3 täiskasvanul.

**Ühenduste kontroll:** Paigalduse ajal ja regulaarselt kasutamise käigus kontrollige kõigi kruviühenduste (L, O, R) pingulolekut ja liitmike (D, E, H, J) stabiilsust.















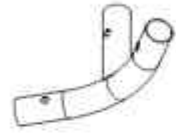



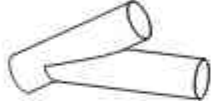

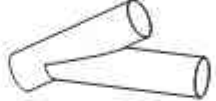
**Hoiustamine:** Enne hoiustamist veenduge, et kõik katted (T, U, V) ja metallosad (A, B, C) on täiesti kuivad ja puhtad. Niiskes olekus hoiustamine võib põhjustada hallituse teket katetele või materjali korrosiooni.

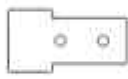
### JURIIDILINE VASTUTUSE DEKLARATSIOON

**Vastutuse piiramine:** Tootja ega müüja ei vastuta varalise kahju, isikuvigastuste või kahjude eest, mis on põhjustatud ebaõigest paigaldusest, hoolduse eiramisest või selles juhendis toodud ohutusnõuete mittejärgimisest.

**Väramatu jõud:** Garantii ei kata kahjustusi, mis on põhjustatud väramatust jõust (ekstreemne ilm, üleujutused, tormid). Sellistes tingimustes on kasutaja kohustatud telgi õigeaegselt kinnitama või demonteerima.

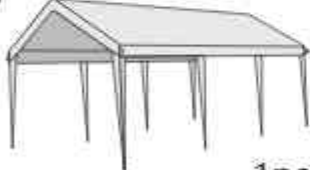
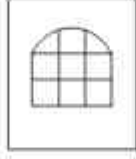
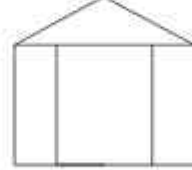
**Kasutusotstarve:** Telgi kasutamine muul kui ettenähtud otstarbel (nt laona, sõidukite garaažina või püsiva varjualusena) toimub kasutaja omal vastutusel ja toob kaasa pretensiooniõiguse kaotuse.

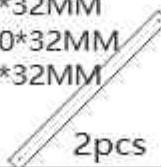
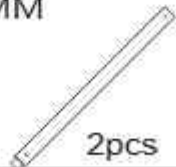
<p>A 1873*38MM</p>  <p>8pcs</p>	<p>A1 (4x6M) 250*38MM (5x6M) 760*38MM (6x6M) 1270*38MM</p>  <p>8pcs</p>	<p>B 1873*38MM</p>  <p>9pcs</p>	<p>C 1920*38MM</p>  <p>8pcs</p>
<p>D</p>  <p>6pcs</p>	<p>E</p>  <p>6pcs</p>	<p>F (4x6M) 1066*38MM (5x6M) 1066*38MM (6x6M) 1920*38MM</p>  <p>4pcs</p>	<p>G 1920*32MM</p>  <p>12pcs</p>
<p>H</p>  <p>8pcs</p>	<p>I 880*38MM</p>  <p>4pcs</p>	<p>J</p>  <p>8pcs</p>	<p>K</p>  <p>8pcs</p>
<p>L</p>  <p>12pcs</p>	<p>M</p>  <p>16pcs</p>	<p>N</p>  <p>16pcs</p>	<p>O</p>  <p>M6*50 34pcs</p>
<p>P</p>  <p>28pcs</p>	<p>Q</p>  <p>4pcs</p>	<p>R</p>  <p>24pcs</p>	<p>S</p>  <p>2pcs</p>
<p>T</p>  <p>1pcs</p>	<p>U</p>  <p>6pcs</p>	<p>V</p>  <p>2pcs</p>	<p>W</p>  <p>62pcs</p>
<p>X 1920*32MM</p>  <p>4pcs</p>	<p>Y 330*32MM (4x6M) 330*32MM (5x6M) 1330*32MM (6x6M) 330*32MM</p>  <p>2pcs</p>	<p>Y1 (6x6M) 1920*32MM</p>  <p>2pcs</p>	

# STEP 1



(A) X2



(A1) X2



(D) X1

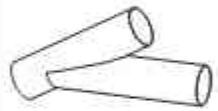

(H) X2



(F) X2

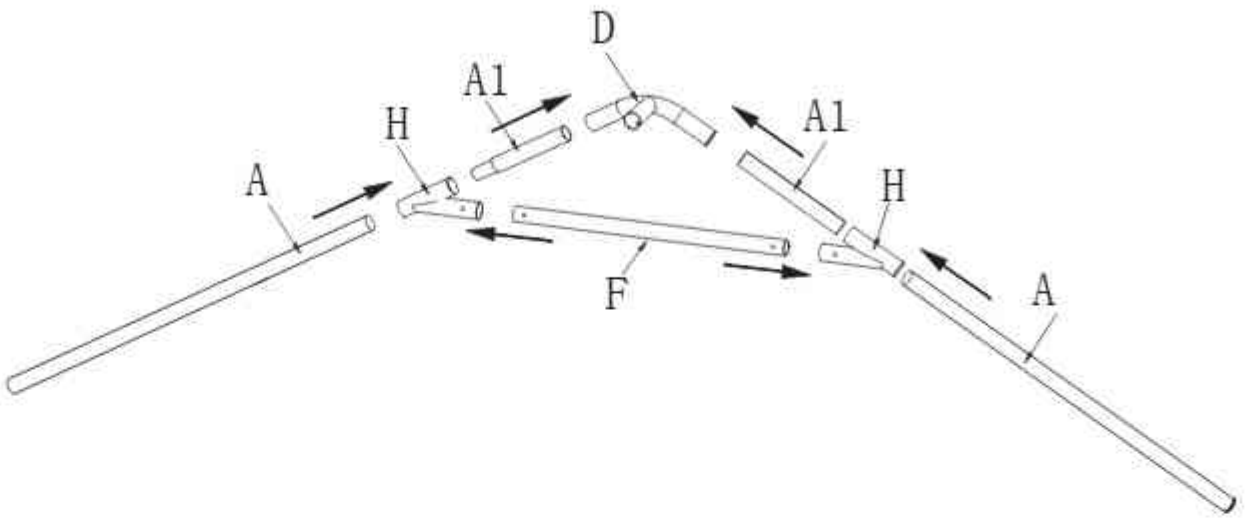

# STEP 2



(D) X2

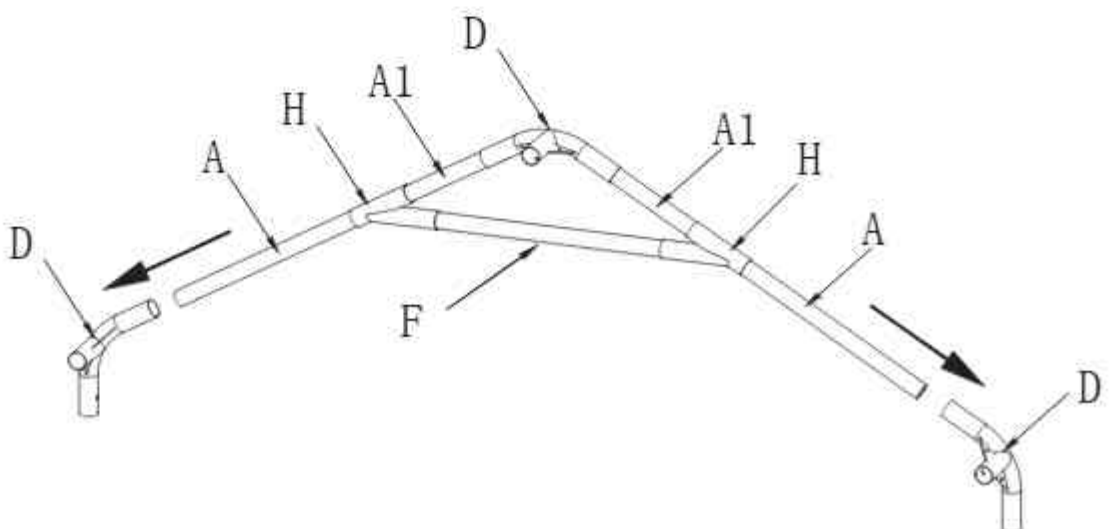

### STEP 3

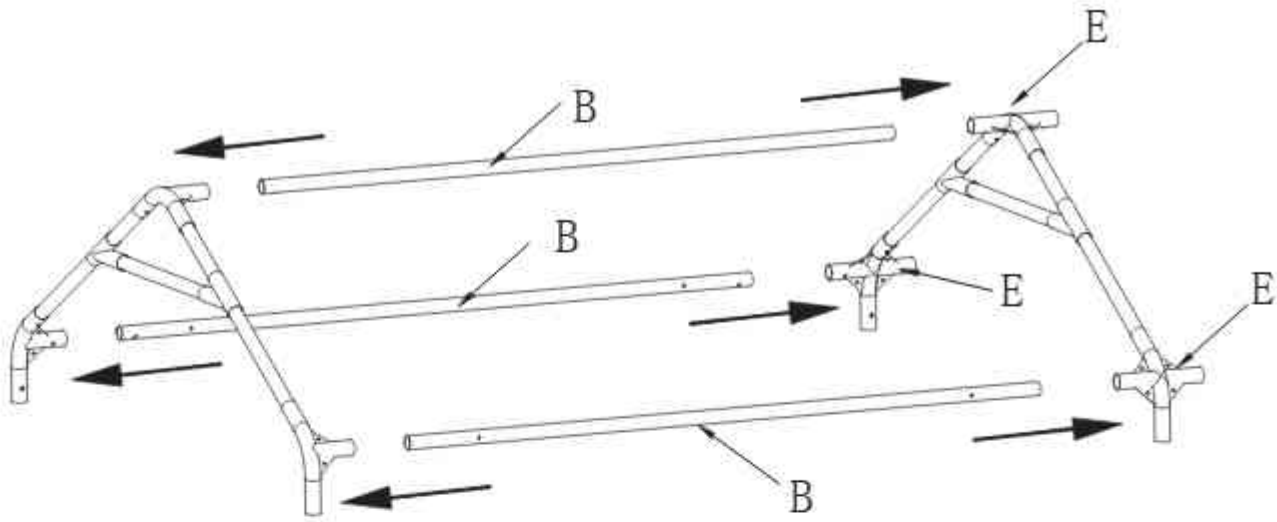

(B) X3



(E) X3

### STEP 4

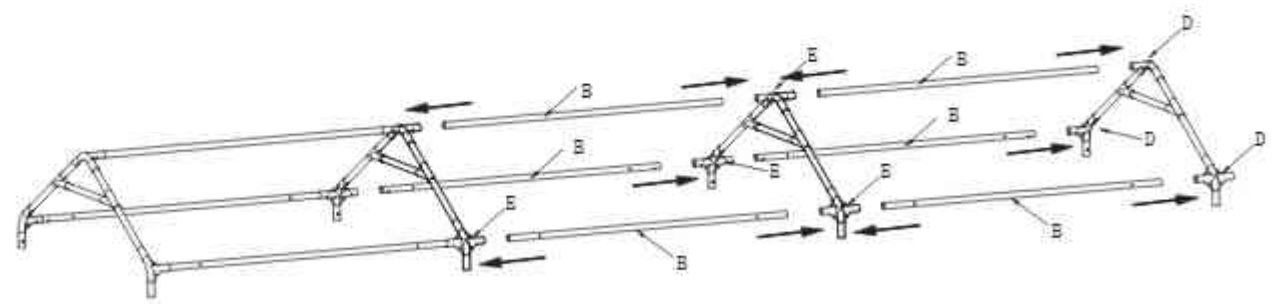

X1

X1

(B) X6

# STEP 5

(G) X6

(I) X16

(M) X8

(N) X8

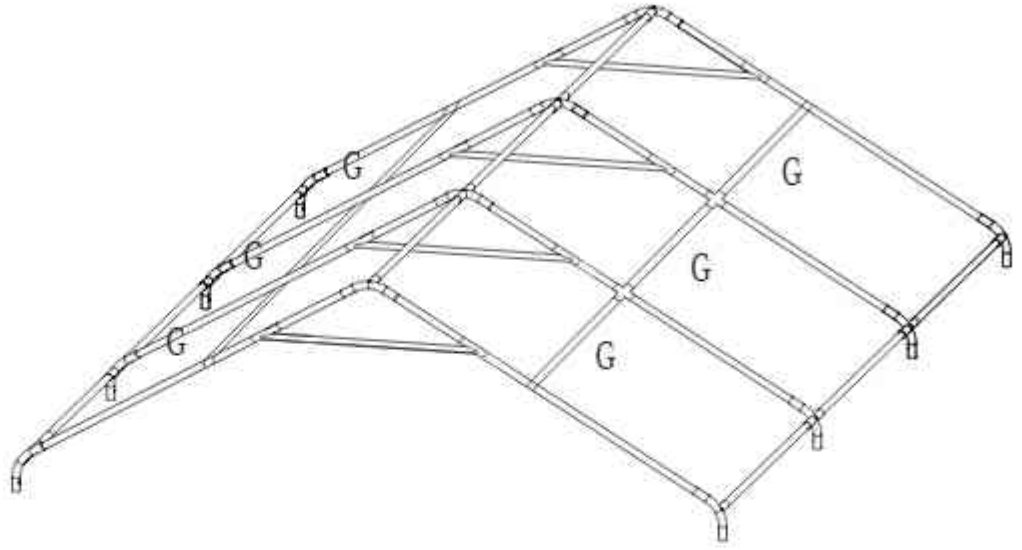

# STEP 6

(T) X1

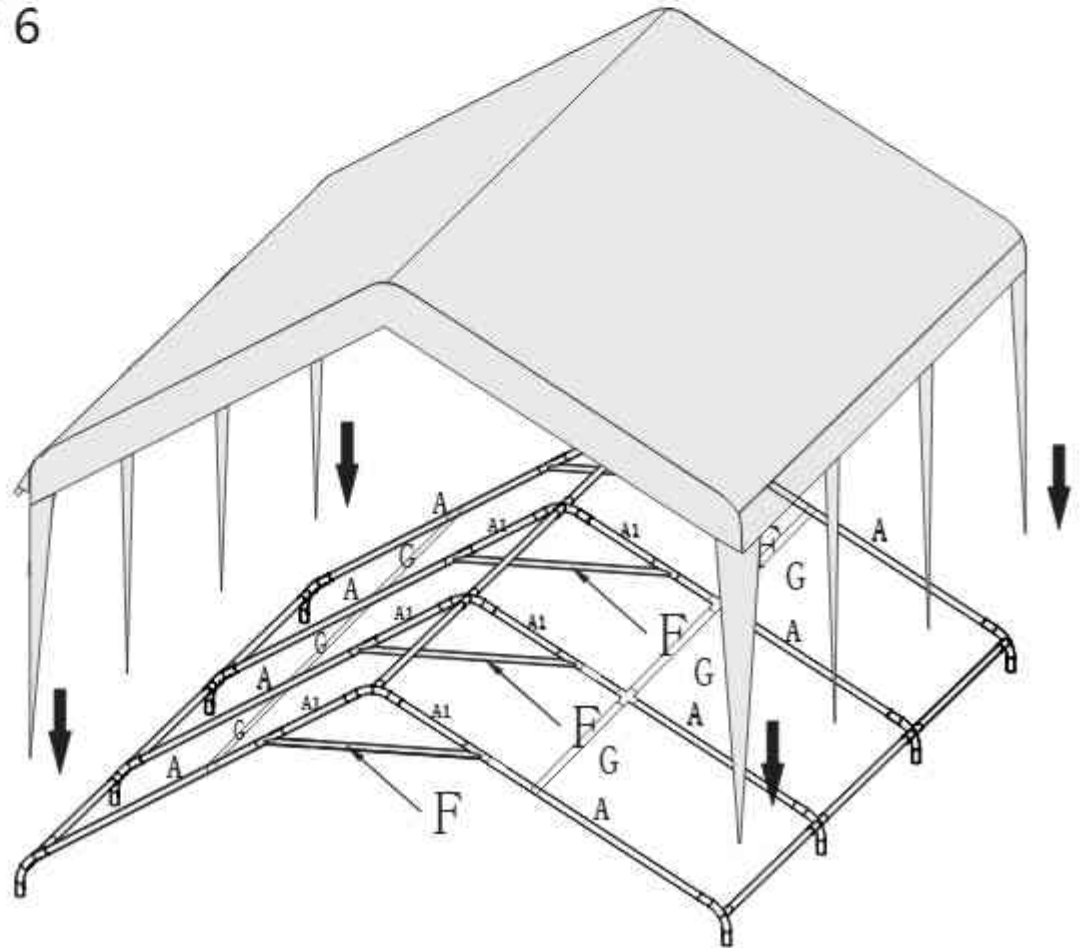

## STEP 7



(C) X1



(L) X1



(K) X1

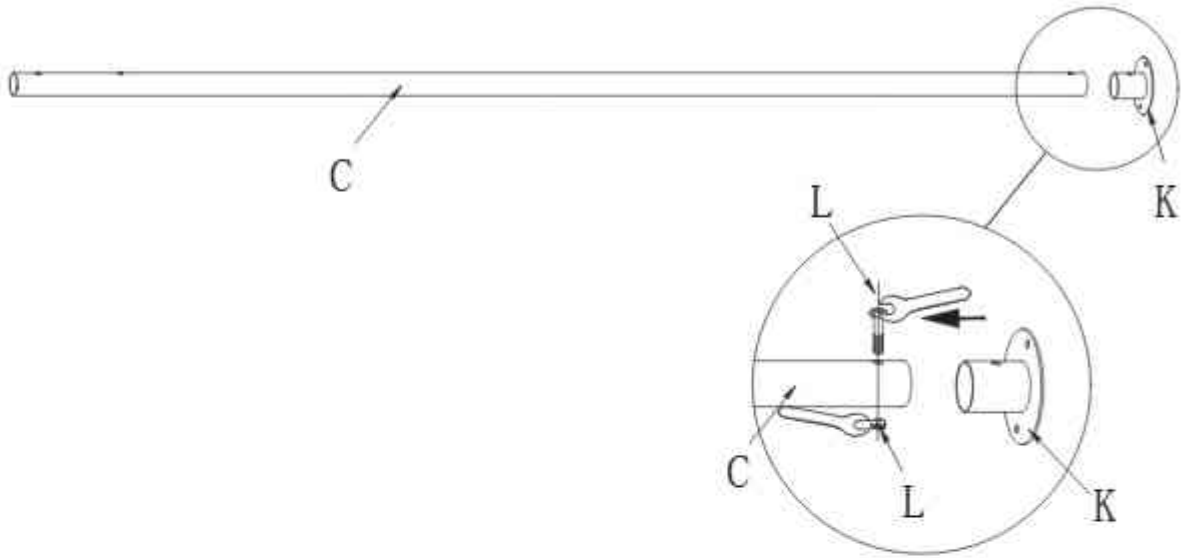

## STEP 8



(C) X8



(J) X8



(I) X4

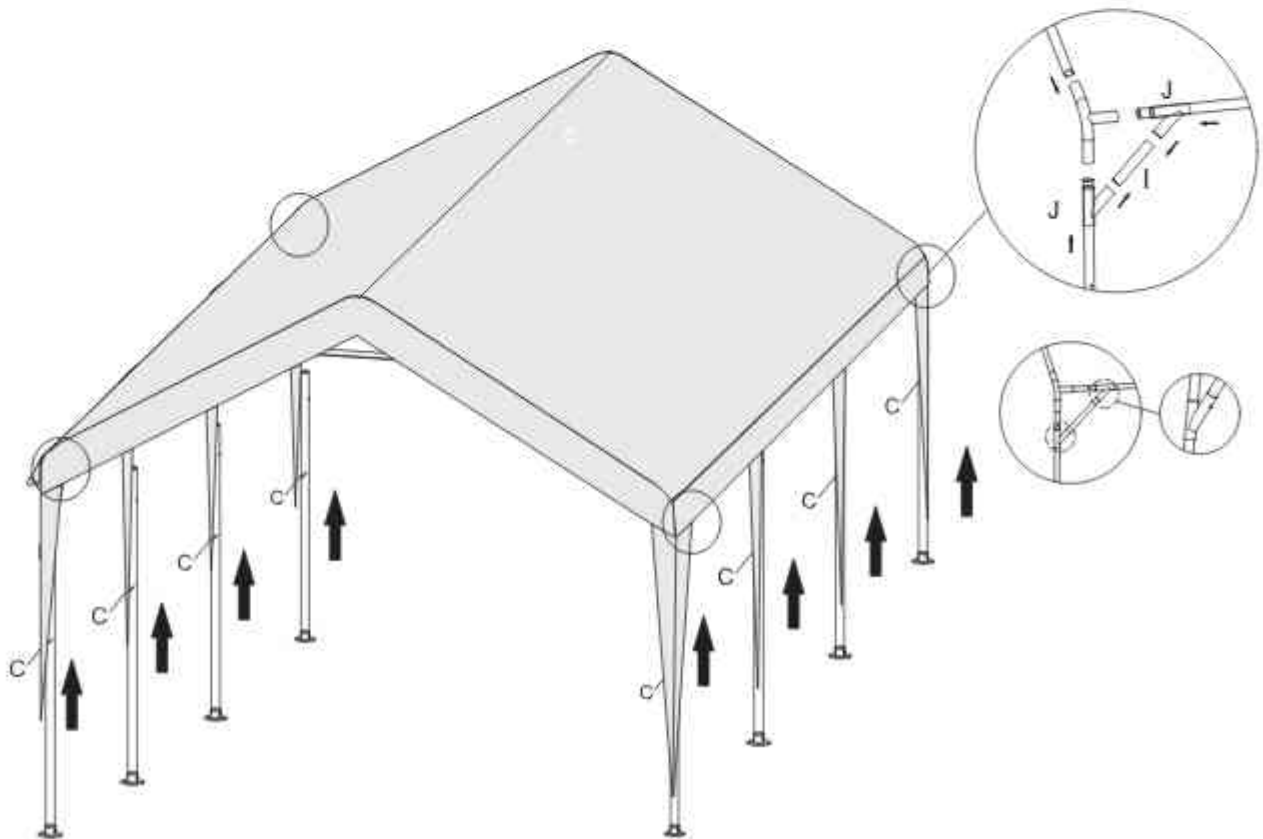



# STEP 9

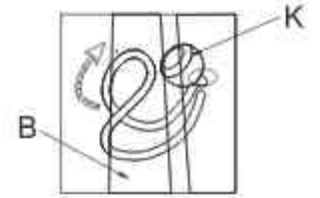

U X6

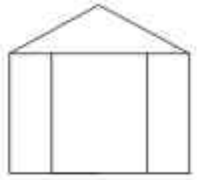
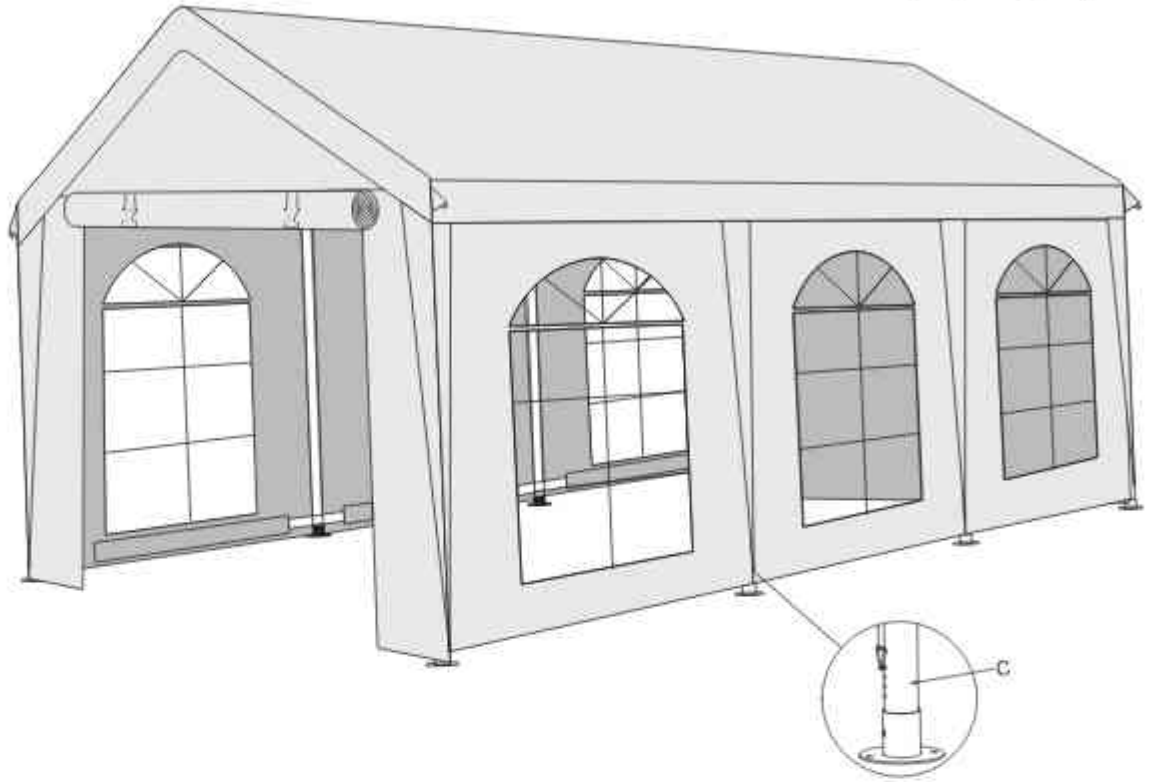

V X2



W X62

# STEP 10

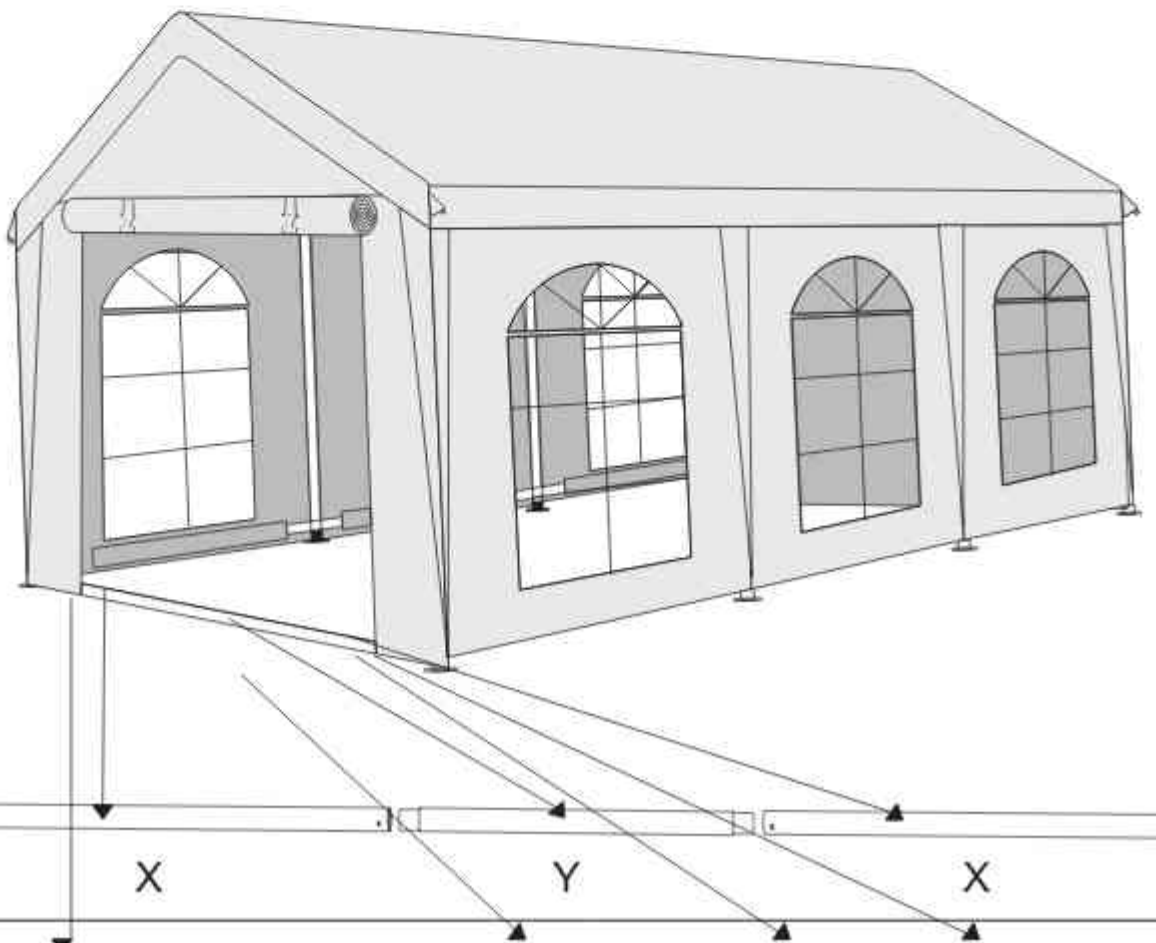

X X2



Y X1



Y1 X1 (6x6M)



## STEP 11



**G** X6



M6\*50

**O** X16



**M** X8



**N** X8

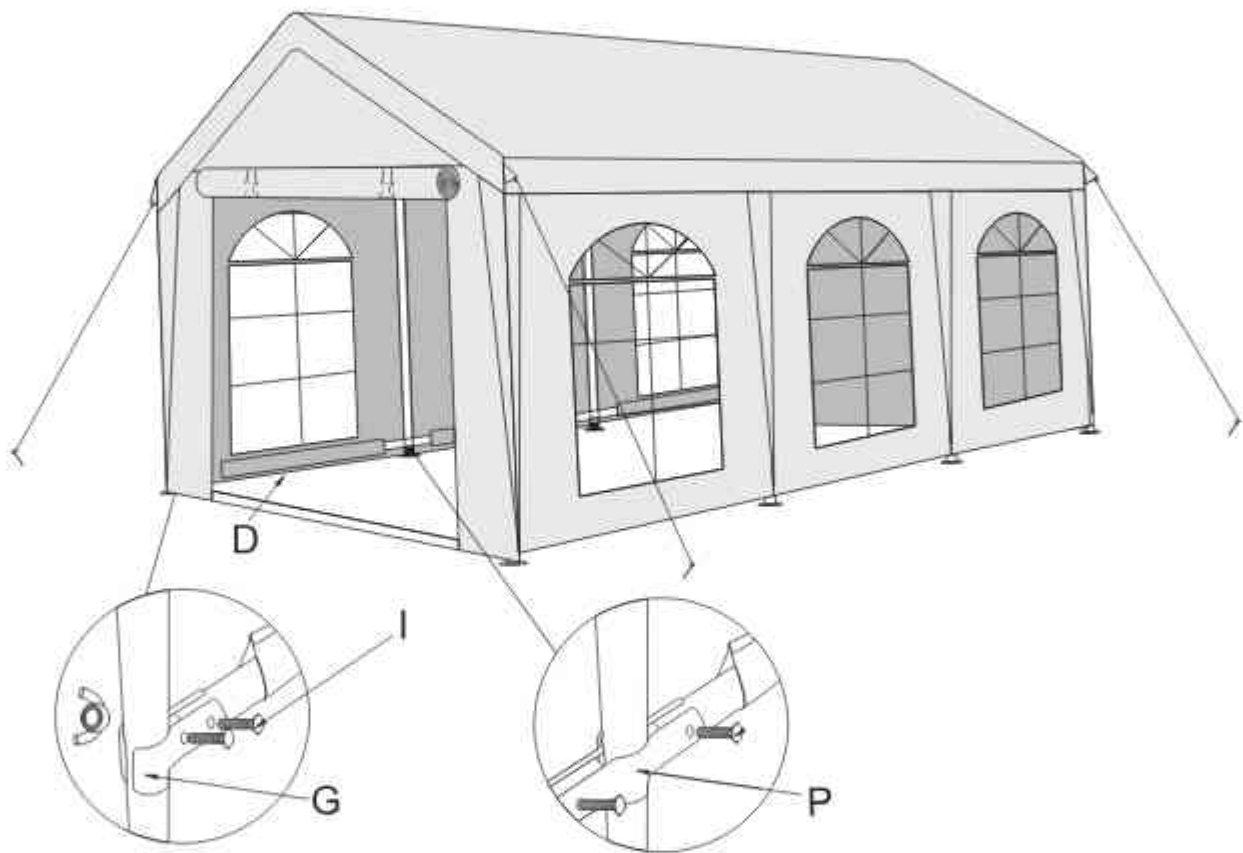

### OHUTUSHOIATUS Lühiajaline kasutamine:

See peotelk on mõeldud eranditult ajutiseks varjualuseks lühiajalistele üritustele. See ei ole mõeldud pikaajaliseks kasutamiseks ega püsivaks katusealuseks. Kohustuslik ankurdamine: Telk peab olema alati korralikult maapinna külge kinnitatud, kasutades kaasasolevaid vaiasid (P), nõõre (Q) ja taldu (K). Ärge kunagi jätke lahtist telki järelevalveta. Ilmastikutingimused: Ebasoodsate ilmastikuolude (tugev tuul, torm, rahe või tihe lumesadu) prognoosi korral tuleb telk viivitamatult lahti võtta. Konstruktsioon ei ole mõeldud taluma äärmuslikku tuule- või lumekoormust. Tuleohutus: Ärge kasutage telgi sees ega selle vahetus läheduses lahtist tuld, grille, soojendeid ega muid soojusallikaid. On oht kahjustada katet (T, U, V) või põhjustada tulekahju. Vee ja lume kogunemine: Kontrollige regulaarselt katusekatet (T), et vältida vihmavee või lume kogunemist. Liigne raskus võib põhjustada metalltorude (A, B, C) deformeerumist või konstruktsiooni kokkuvarisemist.



## ÜKSIKASJALIK MONTAAŽIJUHEND (TEHNILINE LOOGIKA)

Montaažil järgige piltidega juhendis toodud nummerdatud samme: Katuse raami ettevalmistamine (Sammud 1–4): Esmalt pange kokku konstruktsiooni ülaosa (sarikad). Kasutage keskmisi ühendusi (D, H) ja torusid (A, A1, F). Lisage järk-järgult pikitorud (B), kasutades ühendusi (E). Katuse tugevdamine (Samm 5): Paigaldage katuse tugitorud (G). Need on olulised katte stabiilsuse ja vee äravoolu jaoks. Katusekatte paigaldamine (Samm 6): Tõmmake katusekate (T) konstruktsioonile enne, kui tõstate telgi jalgadele. See on ohutum ja lihtsam. Jalgadele tõstmine (Sammud 7–8): Sisestage jalgade torud (C) järk-järgult ühendustesse. Iga jala alaossa paigaldage tald (K). Seinte ja alumise raami paigaldamine (Sammud 9–10): Kinnitage akendega külseinad (U) ja sissepääsuosad (V) elastsete kummisidemete (W) abil. Lõpuks ühendage alumised torud (X, Y), et tagada konstruktsiooni maksimaalne jäikus. Lõplik kinnitamine (Samm 11): Kontrollige, kas kõik poldid (O, R) on pingutatud ja telk on vaiadega (P) kindlalt maasse ankurdatud.

### LISASOOVITUSED KASUTAJALE

Tuule suund: Kui püstitate telki kerge tuulega, peaks sissepääs olema suunatud vastu tuult, et vältida "langevarju" efekti.

Tekstiili kaitse: Ärge kasutage elastsete kummisidemete (W) pingutamisel liigset jõudu, et vältida õõside väljarebimist kattest.



Korrosioonigarantii: Kuigi torud on lakitud, soovitame kriimustuste korral montaaži ajal töödelda kohta korrosioonivastase spreiga, kuna tegemist on teraskonstruktsiooniga.

 **MAALETOOJA IDENTIFITSEERIMINE** Maaletooja ja kaubamärgi **BRIMO** omanik: Hana Godušová Aadress: Lermontovová 911/3, Bratislava, Slovakkia

## KAHE TELGI ÜHENDAMINE - pikkusele 12m ja rohkem (PIKENDUS)

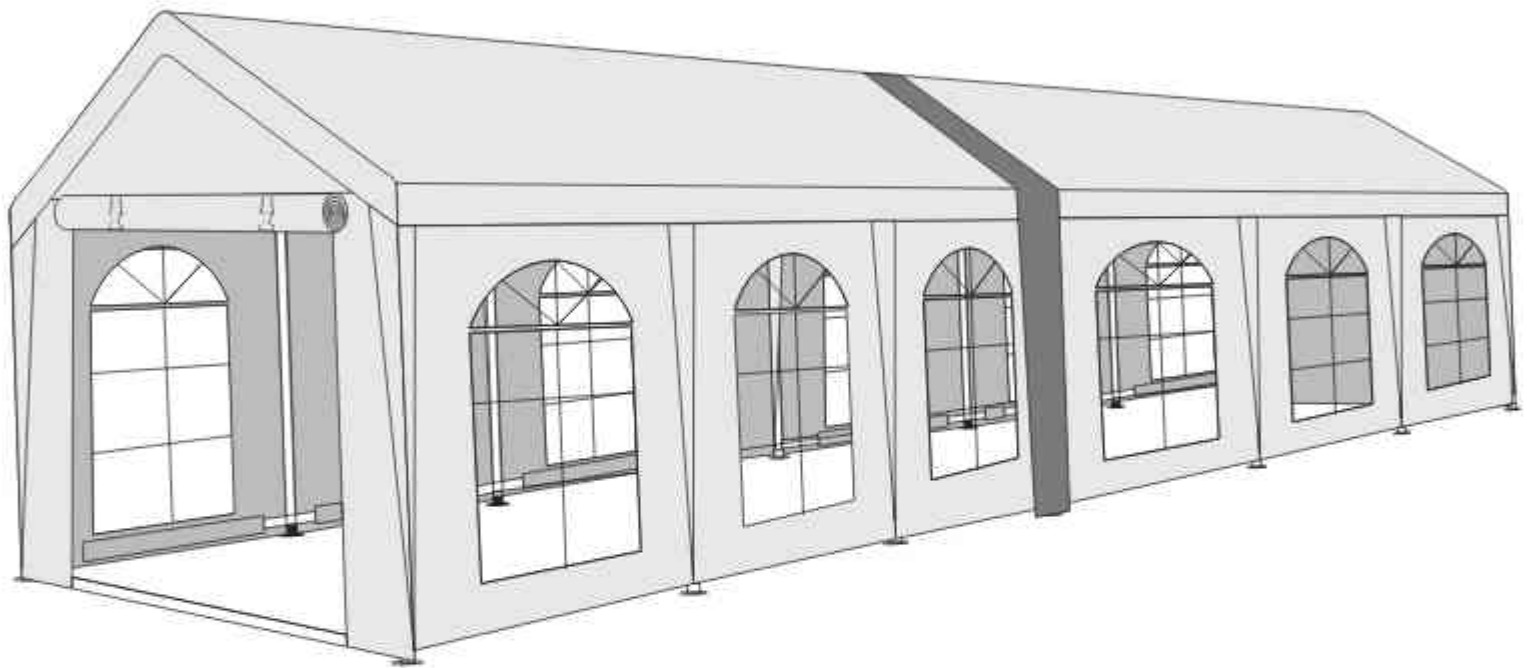
☒ Ostes 12 m või pikema telgi, on see lisatarvik automaatselt hinna sees. Telkide 4x6 m, 5x6 m, 6x6 m puhul on tegemist lisatasu eest saadava tarvikuga.

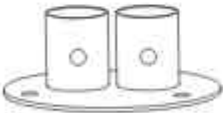
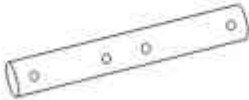
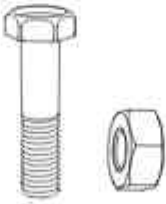
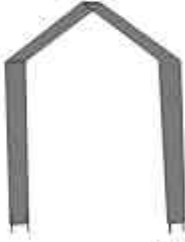

<b>A</b>  2PCS	<b>B</b>  2PCS	<b>C</b>  4PCS	<b>D</b>  1PCS
<b>E</b>  2PCS	<b>F</b>  4PCS	<b>G</b> <b>S</b> 4PCS	

### STEP 1

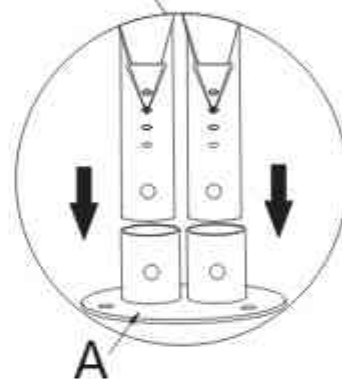
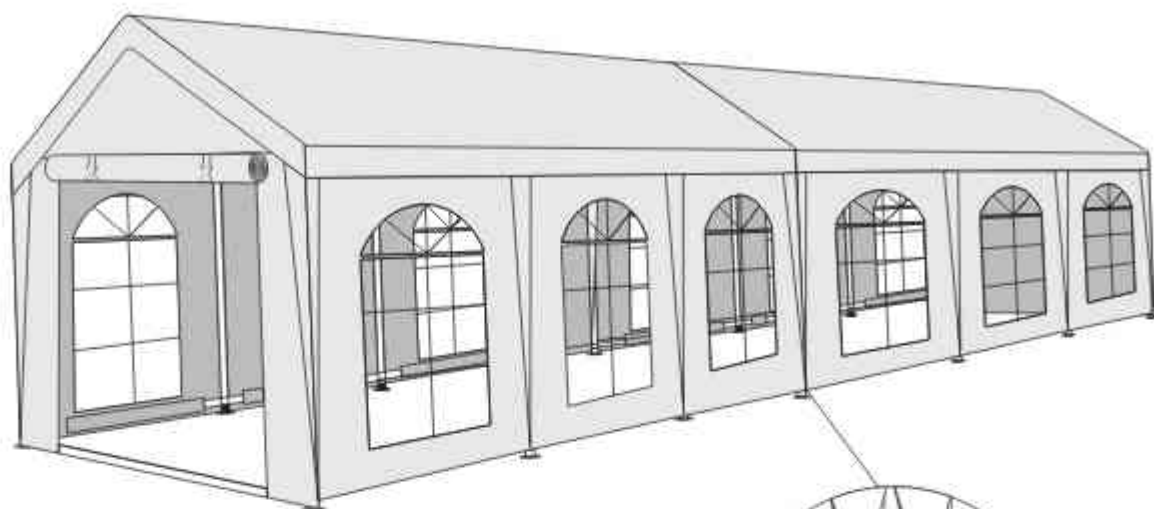
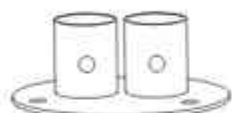

(A) X2

### STEP 2

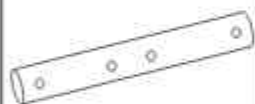

(B) X2



(C) X4



(E) X2

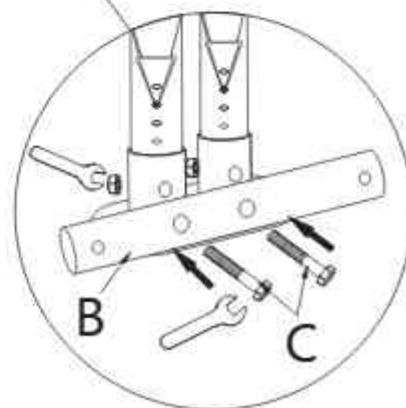
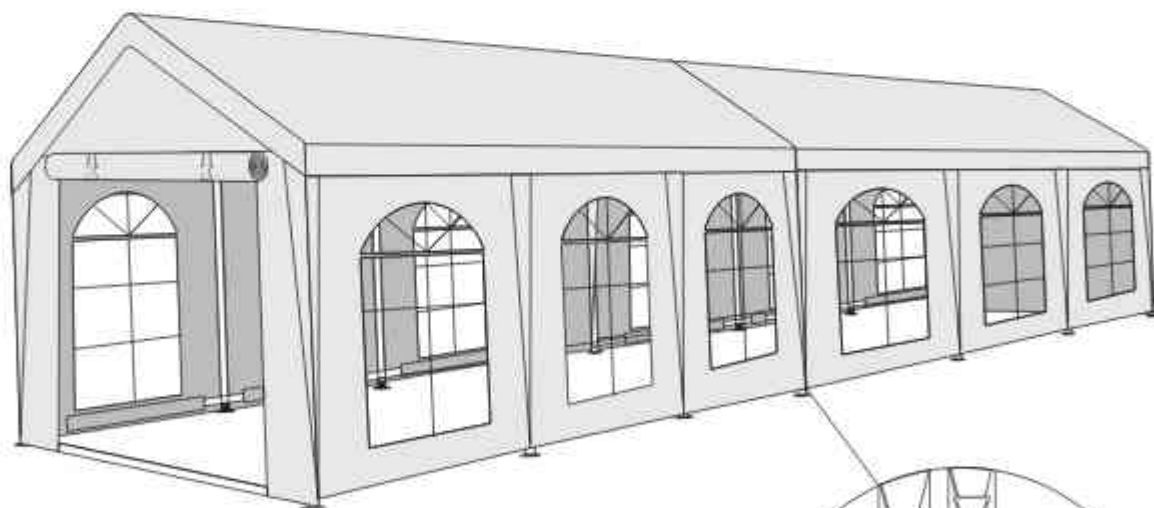

STEP 3



Ⓓ X1

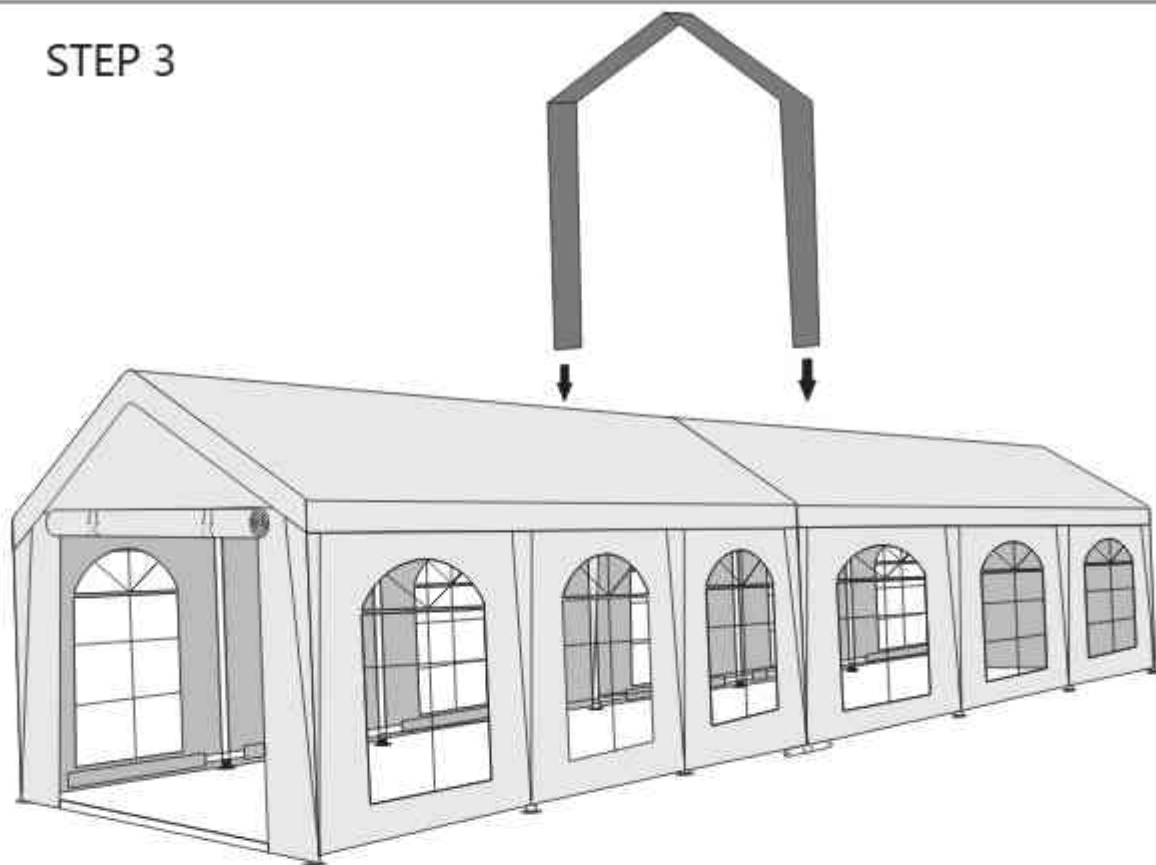

STEP 4



Ⓕ X4

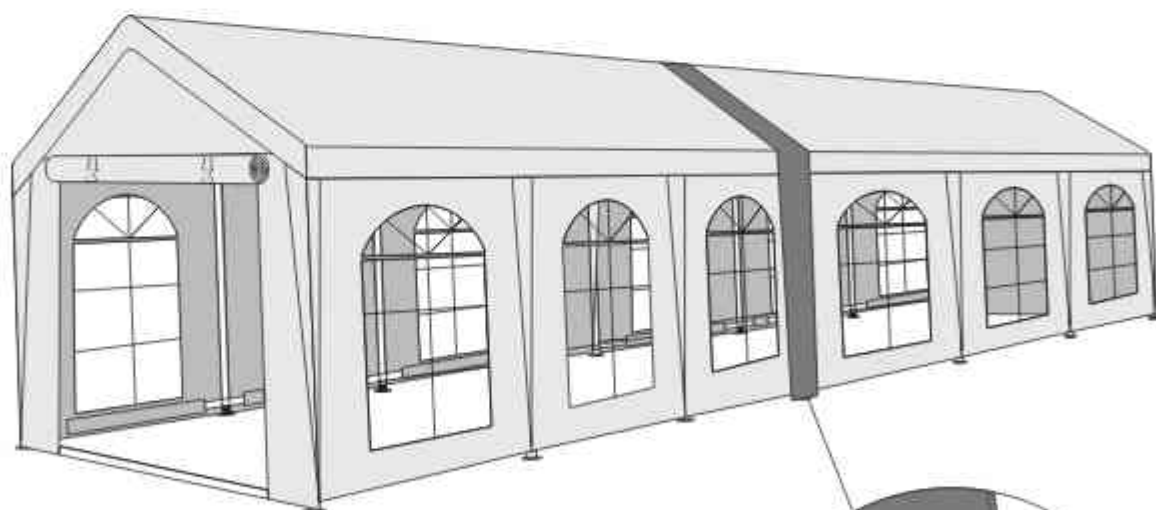

S

Ⓖ X4

